



Safety Sensor for Swing Doors

SSS-5

SSS-5S1
SSS-5M1
SSS-5L1



English

COMPLIED STANDARDS
DIN18650-1:2010
EN 12978:2003 +A1:2009
EN16005:2012
EC type examination
44 205 13738001

User Manual (Original)

We would like to thank you for purchasing this product. Before using, please read the following instructions carefully.

WARNING Disregarding this symbol may result in serious injury or death

CAUTION Disregarding this symbol may result in injury or damage to equipment

Note Special attention is required when this symbol is shown

EN16005 Setting required to conform with EN16005

1 General Description / Features

- The SSS-5 is a microprocessor controlled active infrared presence detector for swing doors.
- 6 detection spots per PCB unit provide a wide detection area.
- The detection distance to the floor is set automatically by pressing a Push Switch.
- The detection range can be adjusted manually, using dip switches in increments of 50mm
- The relay output can be changed from NO to NC using a dip switch.
- Self diagnostic and monitoring functions are implemented.

2 Components

The illustration below shows the standard configuration of SSS-5L1 with one PCB units.

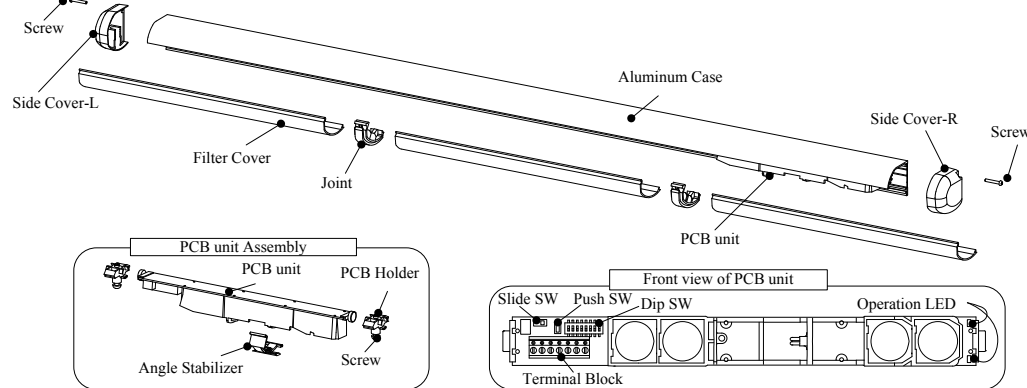

Table.1 Information of SSS-5

Model name	Length [mm]	Filter Cover	Joint	(3)
SSS-5S1	360	1	0	2
SSS-5M1	692	2	1	3
SSS-5L1	1023	3	2	3

Accessories

- (1) Installation Instruction
- (2) Wire Sheath 600 [mm]
- (3) Mounting Screws 4x16 [mm]
- (4) Communication Cable
- (5) Jamb Hole Cover A/B
- Mounting Screws 3x10 [mm]

3 Mounting and Wiring Information

3.1. Notice



Before mounting this sensor please note the following remarks.

- Do not mount the sensor higher than 2.6 [m] (8' 6").
- Do not mount the sensor where rain or snow will fall directly on the unit.
- Ensure the minimum of reflected sunlight from the floor.
- Ensure no condensation gets onto the sensor.
- The Aluminum Case(s) should be located close to the Leading edge of the door to maximise safety detection.

6 Be careful not to drop the sensor, during transportation and installation. It may cause the sensor to break.

3.2 Mounting Hole



Drilling may cause Electric shock! When drilling, pay attention to hidden wires.

Drill fixing holes as illustrated below. When installing the SSS-5 on both sides of the door it may be necessary to drill a wiring hole through the door. (Ref. 3.6 Plan View of SSS-5 Installation)

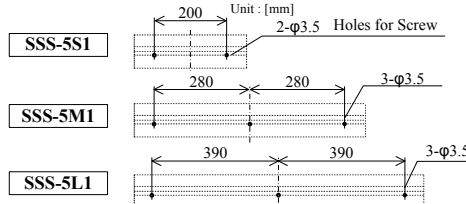
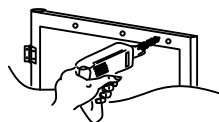

3.3 Mounting the Aluminum Case

- Unscrew the Side Covers and remove the Filter Cover.
- Remove Angle Stabilizer.
 - Lift and slide the Angle Stabilizer to the side as indicated.
 - Push the Angle Stabilizer with your thumb to remove it from the Aluminum Case.
- Remove the PCB Unit. Loosen the Screw on the PCB Holder and slide it aside to remove the PCB Unit.
- Fix the Aluminum Case to the door with Screws.

3.4 Replacing the PCB unit(s)



When replacing the PCB unit it is very important that the side with "LEADING EDGE" marked on it is inserted so that it is closest to the leading edge of the door. This will ensure maximum pedestrian safety at the door edge.

- Remove the Terminal Block from the PCB unit.
- Insert the PCB unit into the Aluminum Case, making sure that the side marked "LEADING EDGE" is closest to the leading edge of the door. Attach the Angle Stabilizer and tighten the screws on the PCB Holders.

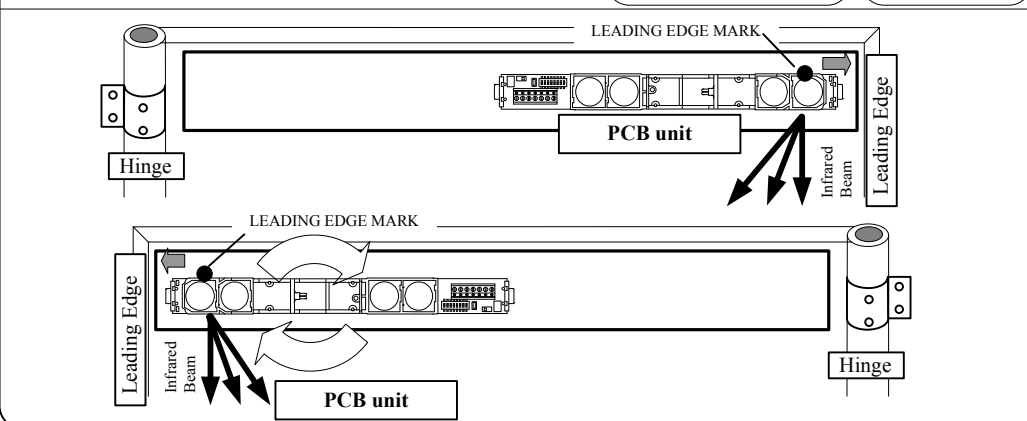

3.5 Wiring to the door controller

Install the Jamb Hole Cover and Wire Sheath when wiring to the door controller.

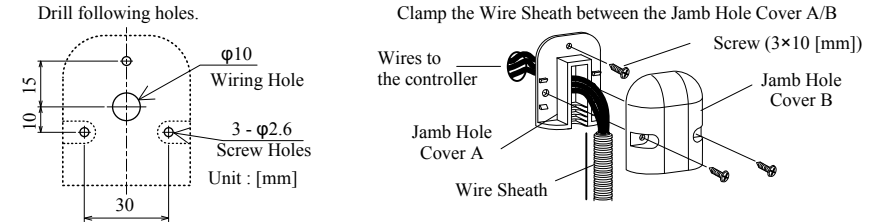

Connect the wires to the door controller using the Terminal Block

Wire size 0.15 to 3.5 [mm²]

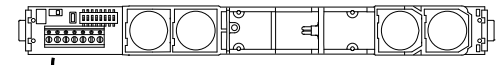

1	Power supply (AC/DC 12~24[V])
2	Relay Output (Common)
3	Relay Output1
4	Relay Output 2(Another PCB Unit Output)
5	TEST Input (-)
6	TEST Input (+)

3.6.1 Option 1: Plan View of SSS-5 Installation

(PCB units on both sides of the door wired back to the Door Controller independently)

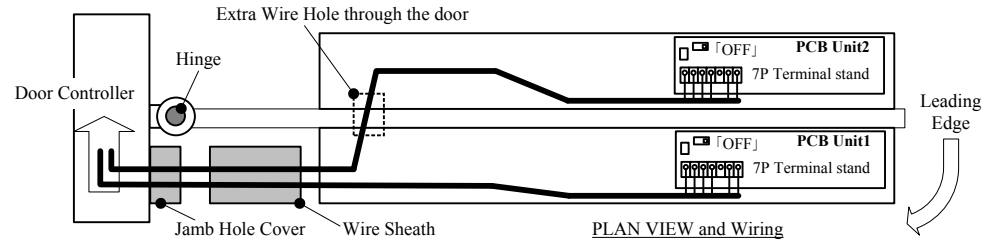

3.6.2 Option 2: Plan View of SSS-5 Installation

(PCB units connected using Communication Cable and only 1 PCB units is wired back to the Door Controller)

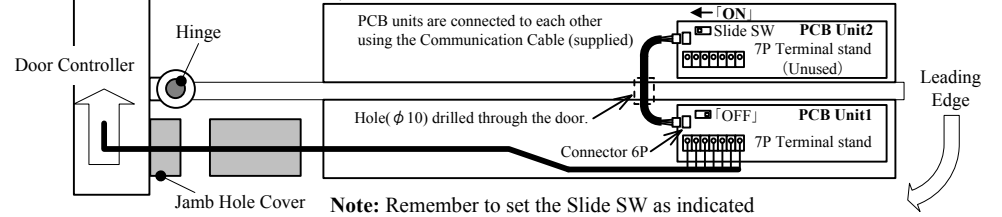

4 Dip Switch Settings

In order to prevent dangerous door movement please configure sensor Dip-SW settings before supplying power to the sensor.

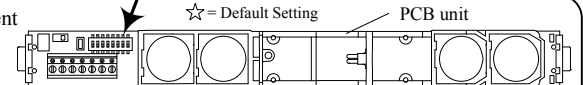

4.1 TEST Input

When connected to a door controller without a TEST input, set to "A". When connected to a door controller with a TEST input, set to "B" before wiring. Refer to [6. Timing Chart of events].

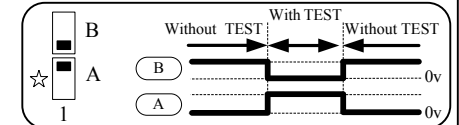

EN16005 Set to "B" to comply with EN16005

4.2 Optical Interference

When two SSS-5's are installed in close proximity, optical cross interference between SSS-5's might cause mis-operation. To avoid this, different frequency settings should be selected using DIP Switch #2.

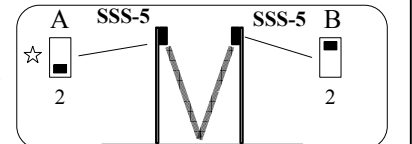

4.3 Relay Output Mode

Refer to [6. Timing chart of events] for full details on Relay Output Mode.



4.4 Masking detecting spots

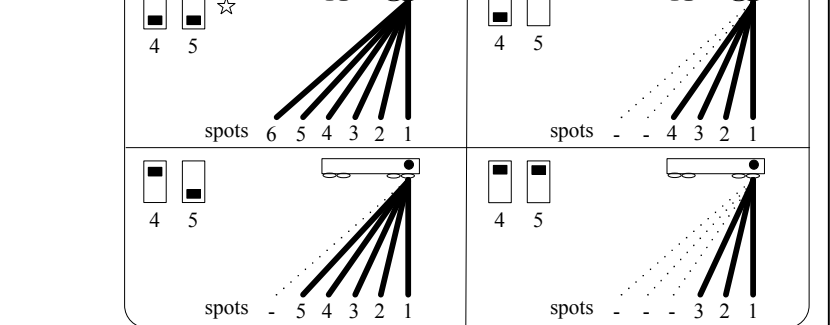

4.5 Detection Range

6 7 8	50mm	6 7 8	250mm
6 7 8	100mm	6 7 8	300mm
6 7 8	150mm	6 7 8	400mm
6 7 8	200mm	6 7 8	500mm

Set Non-Detection distance (A)
EN16005 Check that the detection range conforms to EN16005

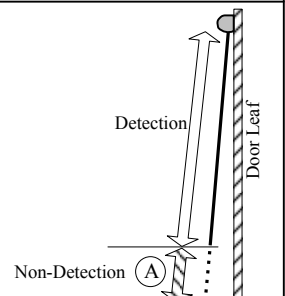

5 Detection Angle Adjustment

The detection angle can be adjusted between 5 ~ 25 [deg] in 5 [deg] increments using the Angle Stabilizer.

Example) Changing angle from 5° to 25°

- Slide
- Lift
- Rotate PCB unit
- Slide Back

EN16005 Check that the detection area position conforms to EN16005

6 Timing chart of events

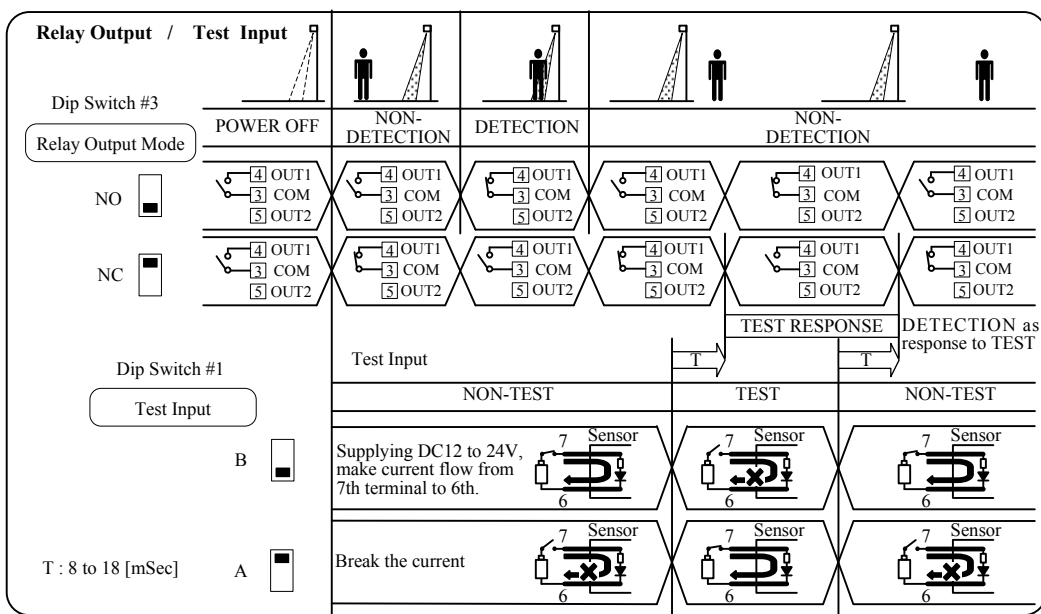

7 LED information

7-1 Normal state

State	Red LED	Green LED
Non-Detect	○ OFF	✳ ON
Detect	✳ ON	○ OFF

7-2 Error state

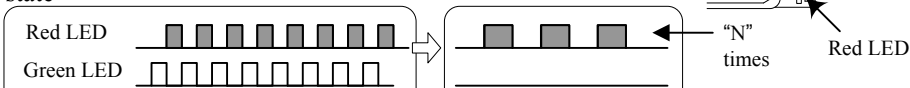

N	Error category	Cause	Solution
1	Environmental error	Environmental noise or the reflection level from the floor is too low.	Execute the "TEACH" from Section 8 whilst laying a sheet of white paper on the floor.
3 over	Other Error	Internal component failure	Change the units.

7-3 Teaching state See Section 8

8 Teaching

Conduct the following steps with the Filter Cover off.

- Check the wiring connection and supply power.
- Execute "TEACHING"

"TEACHING" is necessary to make the sensor work properly, that is to learn the distance from the sensor to the floor.

STEP 1.
Press the "Push SW" switch for more than 2 seconds.

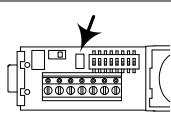

STEP 3.
After STEP2, LED blinks faster and starts "TEACHING". If during this time, a person or object is in the detection area, try again from STEP 1.

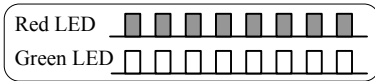

STEP 2.
LED blinks slowly for 10 sec's in a non-detection state. Ensure that there are no people or objects (ladder etc) in the detection area during this time.

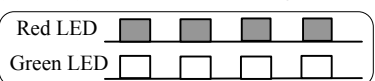

STEP 4.
After STEP3, the green LED blinks once and then this process is completed.

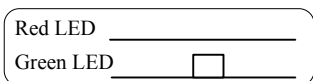

- Check the adjustments, range and other setting.

9 Detection Area

9.1 FRONT VIEW

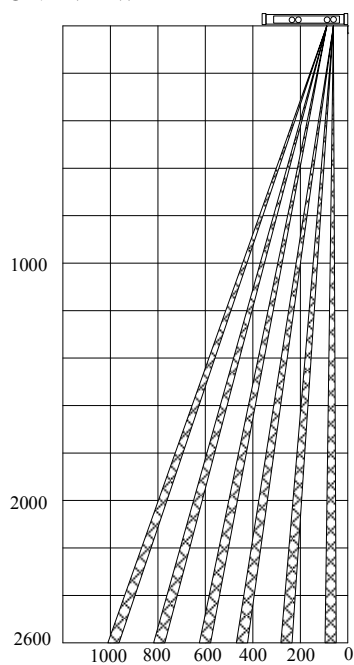

9.2 SIDE VIEW

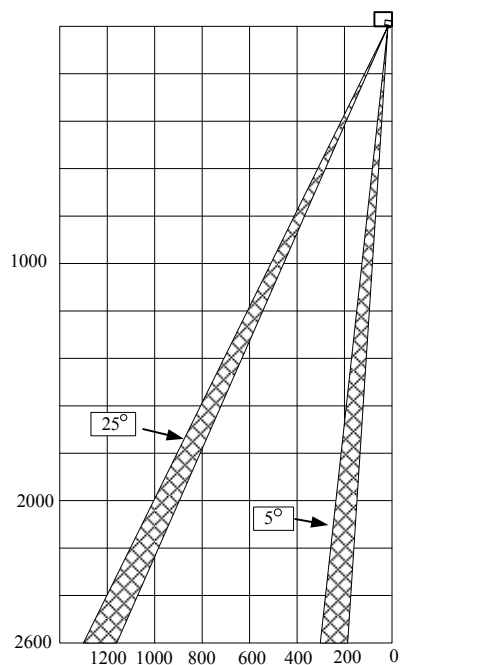

10 Detection Range Check without Filter Cover

Check the detection range without the Filter Cover attached. Put a test object in the detection area to check the detection patterns and other Dip Switch settings. Tests according to local standards should be carried out.

After this check, Turn power off.

EN16005 Check that the detection area conforms to EN16005

When the test is completed, go to Section 11 to install the Filter Cover and Side Cover. If an error occurs, re-check the settings referring to Section 3.

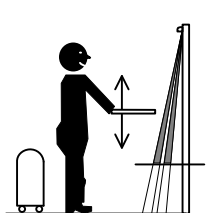

11 Replacing the Filter Cover and Side Cover

1 Installing the Filter Cover:

- First fit the upper side of the Filter Cover into the full length of the Aluminum Case.
- Slightly bend the Filter Cover at one end to latch it onto the bottom lip of the Aluminum Case.
- Slide your hand along the bottom lip to lock the Filter Cover onto the Aluminum Case all along the length of the Aluminum Case.

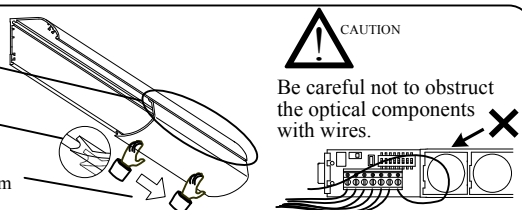

2 Attaching the Joint

- Snap the Joint into the Aluminum Case.
- Slide the Joint so that it fits snugly into the Filter Cover. Make sure there are no gaps left.
- Attach remaining Filter Covers as illustrated

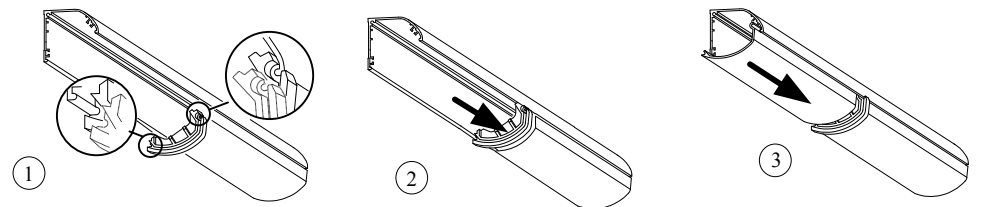

3 Cut out the Side Cover wiring point and insert the Wire Sheath into it.

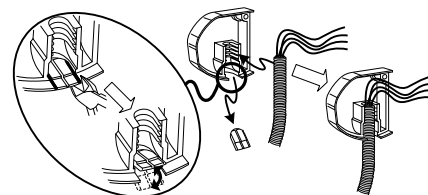

4 Attach the Side Cover with Screws provided.

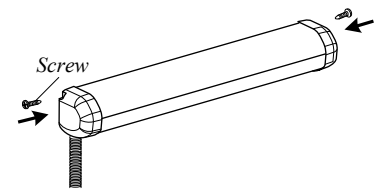

12 Final Detection Range Check

After the Filter Cover is fitted, confirm that the detection range is as expected and conforms with local regulations.

EN16005 Check that the detection area conforms to EN16005

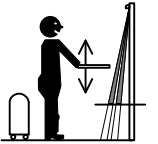

13 Technical Data

MODEL	Safety Sensor for Swing Doors SSS-5		
TECHNOLOGY	COMPLETE STATIONARY DETECTION with PSD DISTANCE MEASUREMENT		
POWER SUPPLY	AC/DC 12~24[V] ±10%	BEAM ANGLE ADJUSTMENT	5, 10, 15, 20, 25 [degrees]
CURRENT CONSUMPTION	95 [mA] @ DC12[V] 55 [mA] @ DC24[V] 1.7 [VA] @ AC12 [V] 2.3 [VA] @ AC24[V]	RESPONSE SPEED	LESS THAN 100 [mSec]
	RELAY OUTPUT	DIP SW FUNCTIONS	TEST INPUT : 1 [BIT] OPTICAL INTERFERENCE : 1 [BIT] RELAY OUTPUT MODE : 1 [BIT] MASKING DETECTING SPOTS: 2 [BIT] DETECTION RANGE: 3 [BIT]
TEST INPUT	6 [mA] Max. at 24 [VDC]	OPERATING TEMPERATURE	-20 ~ +60 [° C]
MOUNTING HEIGHT	2.6 [m] Max	WEIGHT	SSS-5S1: 350[g] APPROX. SSS-5M1: 540[g] APPROX. SSS-5L1: 760[g] APPROX.
DETECTION RANGE	0 - 2.55 [m] Max		

14 Dimensions

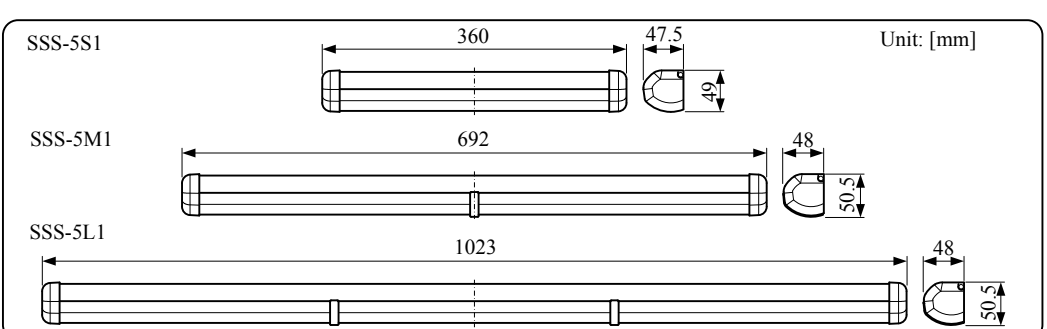

15. EC DECLARATION OF CONFORMITY

Description of Product:
SSS-5 Safety Sensor for Swing Doors.
Complete stationary detection with PSD distance measurement.

Directives Fulfilled:
DIRECTIVE 2006/42/EC Machinery Directive
DIN 18650-1:2010 Powered pedestrian doors Part 1: Product requirements. Chapter 5.7.4
EN12978:2003 +A1:2009 Industrial, commercial and garage doors and gates - safety devices for power operated doors and gates - Requirements and test methods.
EN62061:2005 Functional safety of electrical/electronic/programmable electronic safety-related systems.
EN ISO 13849-1:2008 /AC:2009 Safety of machinery - Safety-related parts of control systems.
EN 16005:2012 Power operated pedestrian doorsets - Safety in use - Requirements and test methods. Chapter 4.6.8
EC type examination No. 44 205 13738001

Above EC Type Directives Certified by:	Harmonized Standards Used:	Other Technical Standards Used:
TUV NORD CERT GmbH Langemarckstr.20 45141 Essen Germany Identification No: 0044	EN ISO 13849-1:2008/AC:2009	DIN 18650-1:2005 EN16005:2012
Compiler of Technical File (EC Community) David Morgan / Hotron Ireland Ltd. 26 Dublin Street, Carlow, Ireland Ph: +353 5991 40345 Fax: +353 5991 40543	Location of Declaration (Manufacture) Honda Electron Co., Ltd. 1-23-19 Asahi-Cho, Machida-City, Tokyo, Japan	Declaration made by Teruya Morimoto Director Quality Assurance
		Date 30 September 2015

<Disclaimer> The manufacturer cannot be held responsible for the below.

- Misinterpretation of the installation instructions, miss connection, negligence, sensor modification and inappropriate installation.
- Damage caused by inappropriate transportation.
- Accidents or damages caused by fire, pollution, abnormal voltage, earthquake, thunderstorm, wind, floods and other acts of providence.
- Losses of business profits, business interruptions, business information losses and other financial losses caused by using the sensor or malfunction of the sensor.
- Amount of compensation beyond selling price in all cases.

HOTRON HOTRON CO.,LTD.

Manufacture and Sales
HOTRON CO.,LTD.
1-11-26 Hyakunin-Cho, Shinjuku-Ku, Tokyo, Japan
Phone: +81-(0)3-5330-9221
Fax: +81-(0)3-5330-9222
URL: <http://www.hotron.com>

Sales in Europe
Hotron Ireland Ltd.
26 Dublin Street (2nd Floor), Carlow, Ireland
Phone: +353-(0)59-9140345
Fax: +353-(0)59-9140543
URL: <http://www.hotron.com>